

Part No: 819-040

Schedule 80 PVC & CPVC

Elbow

Desc: 4 PVC 45 ELL FPT SCH80

Part Code: 080

Weight(lbs): 2.712

Weight(kg): 1.23

Weight(gm): 1230

Size: 4"

Color: GRAY

Material: PVC

Connection Fipt x Fipt

Angle 45°

Type Standard

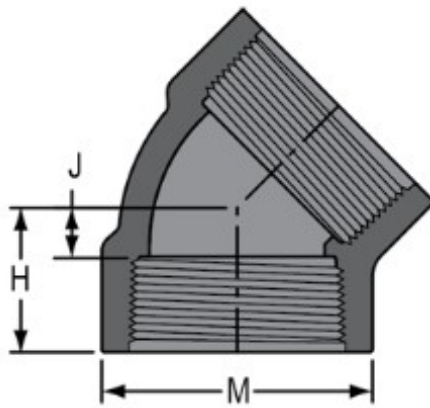

H = 3- 1/4

J = 1-3/4

M = 5- 1/4